

## Features

- Low On-Resistance:  
 $R_{DS(ON)} < 122m\Omega$  @  $V_{GS} = -10V, I_D = -2.7A$   
 $R_{DS(ON)} < 190m\Omega$  @  $V_{GS} = -4.5V, I_D = -2.0A$
- Low Gate Threshold Voltage
- Low Input Capacitance
- Fast Switching Speed
- Low Input/Output Leakage
- Lead, Halogen and Antimony Free, RoHS Compliant "Green" Device (Notes 2, 4 and 6)**
- Lead Free By Design/RoHS Compliant (Note 2)**
- "Green" Device (Note 4)**
- Qualified to AEC-Q101 Standards for High Reliability**



TOP VIEW

SOT-23

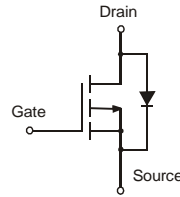

EQUIVALENT CIRCUIT

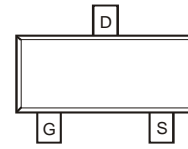

TOP VIEW

## Mechanical Data

- Case: SOT-23
- Case Material: Molded Plastic, "Green" Molding Compound. UL Flammability Classification Rating 94V-0
- Moisture Sensitivity: Level 1 per J-STD-020D
- Terminals: Finish — Matte Tin annealed over Copper leadframe. Solderable per MIL-STD-202, Method 208
- Terminal Connections: See Diagram
- Marking Information: See Page 3
- Ordering Information: See Page 3
- Weight: 0.008 grams (approximate)

## Maximum Ratings @ $T_A = 25^\circ C$ unless otherwise specified

Characteristic			Symbol	Value	Units
Drain-Source Voltage			$V_{DSS}$	-30	V
Gate-Source Voltage			$V_{GSS}$	$\pm 20$	V
Drain Current (Note 1)	Steady State	$T_A = 25^\circ C$	$I_D$	-2.7	A
		$T_A = 70^\circ C$		-2	
Pulsed Drain Current (Note 3)			$I_{DM}$	8	A

## Thermal Characteristics

Characteristic	Symbol	Value	Units
Total Power Dissipation (Note 1)	$P_D$	1.08	W
Thermal Resistance, Junction to Ambient @ $T_A = 25^\circ C$ (Note 1)	$R_{\theta JA}$	115	$^\circ C/W$
Operating and Storage Temperature Range	$T_J, T_{STG}$	-55 to +150	$^\circ C$

## Electrical Characteristics @ $T_A = 25^\circ C$ unless otherwise specified

Characteristic	Symbol	Min	Typ	Max	Unit	Test Condition
<b>OFF CHARACTERISTICS (Note 5)</b>						
Drain-Source Breakdown Voltage	$BV_{DSS}$	-30	—	—	V	$V_{GS} = 0V, I_D = -250\mu A$
Zero Gate Voltage Drain Current	$I_{DSS}$	—	—	-800	nA	$V_{DS} = -30V, V_{GS} = 0V$
Gate-Source Leakage	$I_{GSS}$	—	—	$\pm 80$ $\pm 800$	nA	$V_{GS} = \pm 12V, V_{DS} = 0V$ $V_{GS} = \pm 15V, V_{DS} = 0V$
<b>ON CHARACTERISTICS (Note 5)</b>						
Gate Threshold Voltage	$V_{GS(th)}$	-1.3	-1.8	-2.1	V	$V_{DS} = V_{GS}, I_D = -250\mu A$
Static Drain-Source On-Resistance	$R_{DS(ON)}$	—	97	122	m $\Omega$	$V_{GS} = -10V, I_D = -2.7A$
		—	165	190		$V_{GS} = -4.5V, I_D = -2.0A$
Forward Transfer Admittance	$ Y_{fs} $	—	3.6	—	S	$V_{DS} = -5V, I_D = -2.7A$
Diode Forward Voltage (Note 5)	$V_{SD}$	—	—	-1.26	V	$V_{GS} = 0V, I_S = -2.7A$
<b>DYNAMIC CHARACTERISTICS</b>						
Input Capacitance	$C_{iss}$	—	227	—	pF	$V_{DS} = -10V, V_{GS} = 0V$ $f = 1.0MHz$
Output Capacitance	$C_{oss}$	—	64	—	pF	
Reverse Transfer Capacitance	$C_{rss}$	—	36	—	pF	

- Notes:
- Device mounted on FR-4 PCB.  $t \leq 5$  sec.
  - No purposefully added lead. Halogen and Antimony Free.
  - Pulse width  $\leq 10\mu S$ , Duty Cycle  $\leq 1\%$ .
  - Diodes Inc.'s "Green" policy can be found on our website at [http://www.diodes.com/products/lead\\_free/index.php](http://www.diodes.com/products/lead_free/index.php).
  - Short duration pulse test used to minimize self-heating effect.
  - Product manufactured with Green Molding Compound and does not contain Halogens or  $Sb_2O_3$  Fire Retardants.

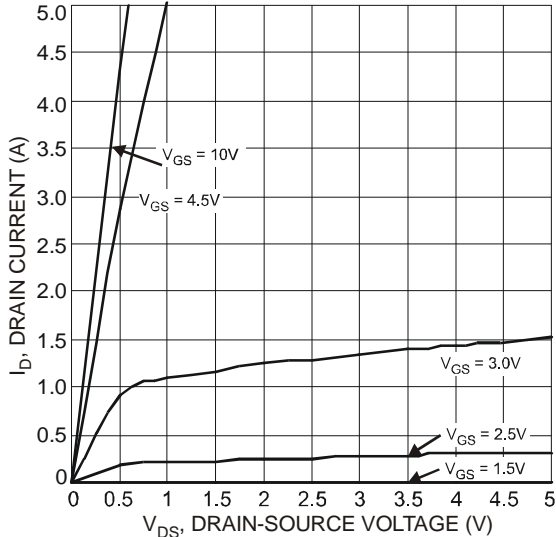

Fig. 1 Typical Output Characteristics

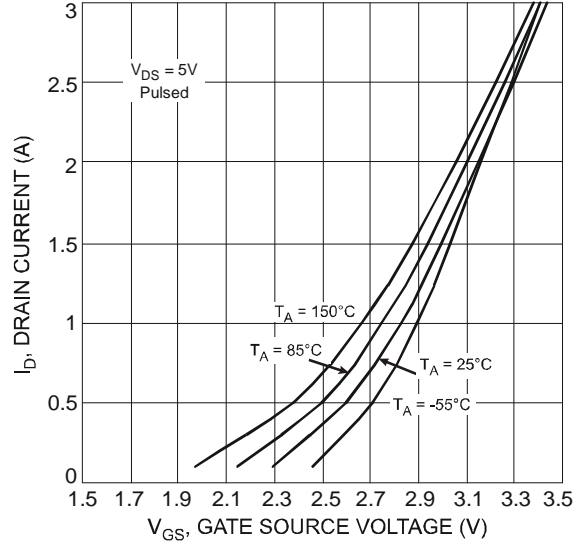

Fig. 2 Typical Transfer Characteristics

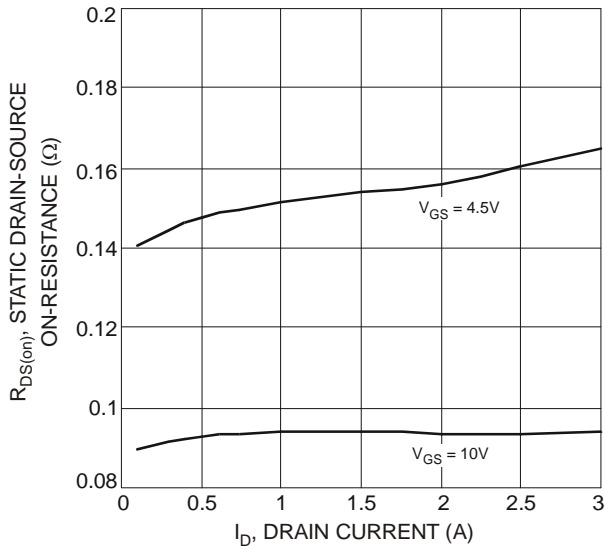

Fig. 3 On-Resistance vs. Drain Current and Gate Voltage

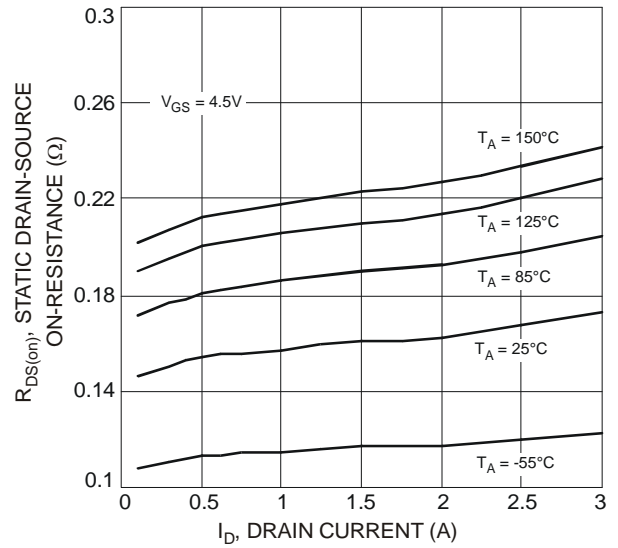

Fig. 4 On-Resistance vs. Drain Current and Gate Voltage

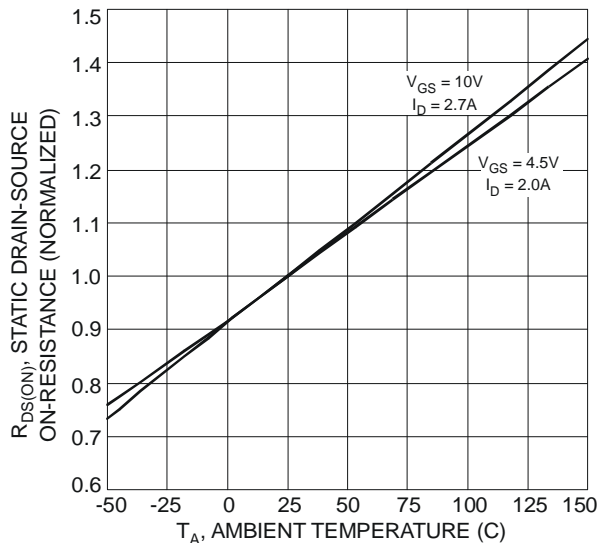

Fig. 5 Normalized Static Drain-Source On-Resistance vs. Ambient Temperature

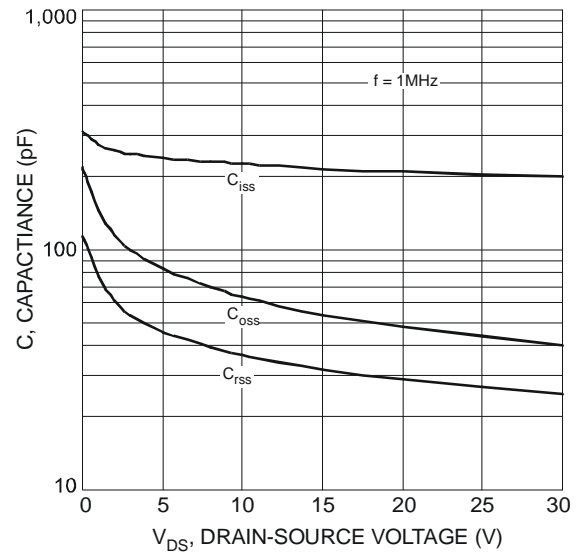

Fig. 6 Typical Capacitance

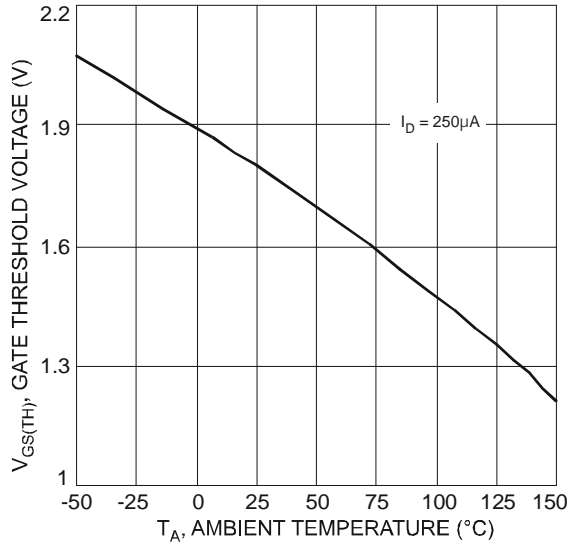

Fig. 7 Gate Threshold Voltage vs. Ambient Temperature

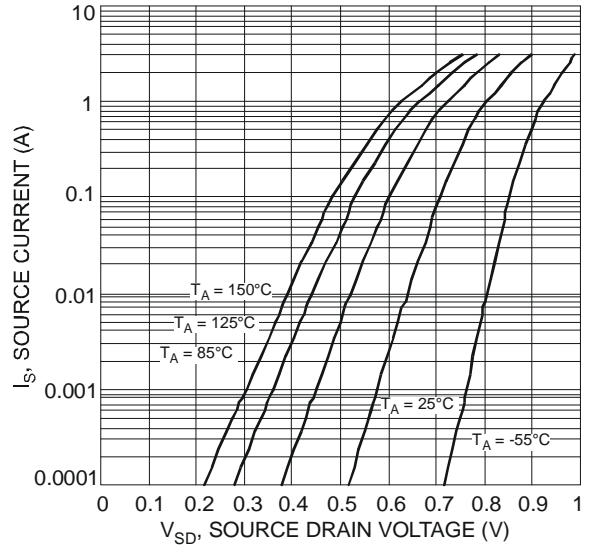

Fig. 8 Reverse Drain Current vs. Source-Drain Voltage

**Ordering Information** (Note 7)

Part Number	Case	Packaging
DMP3160L-7	SOT-23	3000/Tape & Reel

Notes: 7. For packaging details, go to our website at <http://www.diodes.com/datasheets/ap02007.pdf>.

**Marking Information**

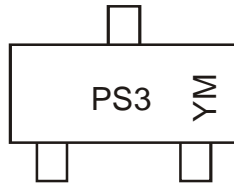

PS3 = Product Type Marking Code  
 YM = Date Code Marking  
 Y = Year ex: U = 2007  
 M = Month ex: 9 = September

Date Code Key

Year	2007	2008	2009	2010	2011	2012
Code	U	V	W	X	Y	Z

Month	Jan	Feb	Mar	Apr	May	Jun	Jul	Aug	Sep	Oct	Nov	Dec
Code	1	2	3	4	5	6	7	8	9	O	N	D

**Package Outline Dimensions**

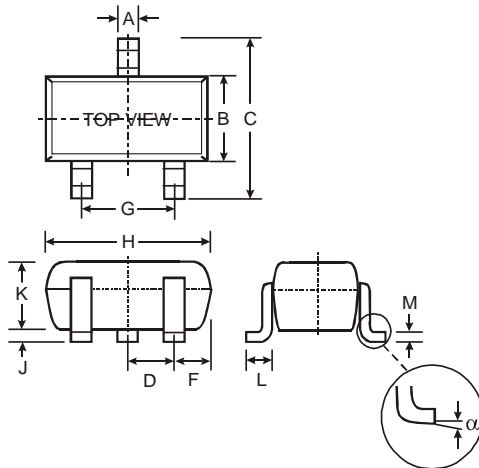

SOT-23		
Dim	Min	Max
A	0.37	0.51
B	1.20	1.40
C	2.30	2.50
D	0.89	1.03
E	0.45	0.60
G	1.78	2.05
H	2.80	3.00
J	0.013	0.10
K	0.903	1.10
L	0.45	0.61
M	0.085	0.180
α	0°	8°

All Dimensions in mm

**Suggested Pad Layout**

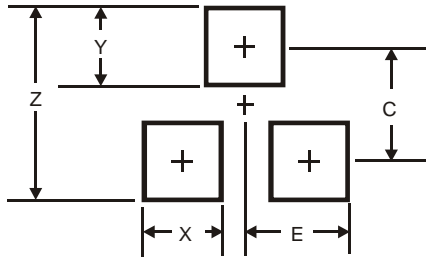

Dimensions	Value (in mm)
Z	2.9
X	0.8
Y	0.9
C	2.0
E	1.35

**IMPORTANT NOTICE**

Diodes Incorporated and its subsidiaries reserve the right to make modifications, enhancements, improvements, corrections or other changes without further notice to any product herein. Diodes Incorporated does not assume any liability arising out of the application or use of any product described herein; neither does it convey any license under its patent rights, nor the rights of others. The user of products in such applications shall assume all risks of such use and will agree to hold Diodes Incorporated and all the companies whose products are represented on our website, harmless against all damages.

**LIFE SUPPORT**

Diodes Incorporated products are not authorized for use as critical components in life support devices or systems without the expressed written approval of the President of Diodes Incorporated.

NEW PRODUCT